

Modular double terminals

6061-DF / 6062-DF / 6063-DF / 6064-DF

with double mantle terminals DFD

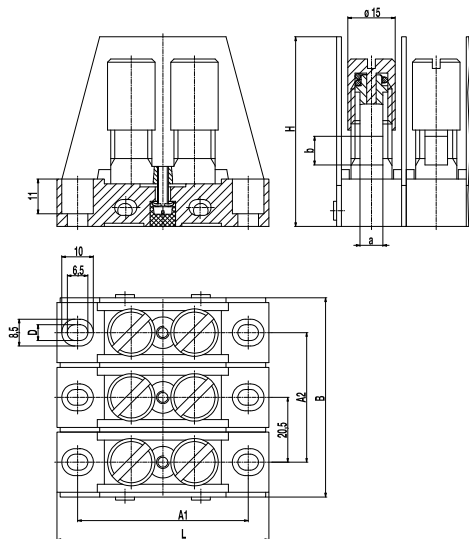

Dimensions (mm)

Type	a	b	L	B	H	A1	A2	D
6061-DF	7,5	9	67	20	50	53	-	4,7
6062-DF	7,5	9	67	43	60	53	20	4,7
6063-DF	7,5	9	67	62	60	53	34	4,7
6064-DF	7,5	9	67	82	60	53	62	4,7

The modular double terminals are available as standard in 1 to 4 pole design. The multicontact blocks have separators between the individual contacts. This provides large area shock-hazard protection and sufficient clearance and creepage distance according to DIN EN 60 998. The mantle terminals are screwed with the porcelain bases and potted at the bottom for insulation and mechanical locking of the screws.

Part Numbers

Type	Part Numbers	PU
6061-DF	31.642.003	30
6062-DF	32.642.003	5
6063-DF	33.642.003	5
6064-DF	34.642.003	14

General Information

No. of poles 1 - 4

Technical Data

Rated Cross Section 1x35 mm²
1x2 AWG

Rated Voltage 500 V acc. to EN 60664-1
Pollution degree 4

Rated Current 135 A

Material

Base material Porcelain, unglazed

Temperature Range [1] -40°C up to 200°C; [2] -40°C up to 120°C

Pressure bolt Nickel plated brass

Spring washer Zinc plated steel

Nut Nickel plated brass

Slotted Bolt Nickel plated brass

Spiral spring Spring steel, blue annealed

Barrier Hardpaper

Options / Accessories

- Larger number of poles

[1] 1-pole version

[2] 2- to 4-pole version due to the separators